

· FABRIC PANEL RETAINER EXTRUSION M 1332.
IDEAL FOR TOWER CONSTRUCTIONS.

· KORPUS-STOFFHALTEPROFIL M 1332.
IDEAL FÜR TURMKONSTRUKTIONEN.

exhibition systems
interior design systems
presentation systems

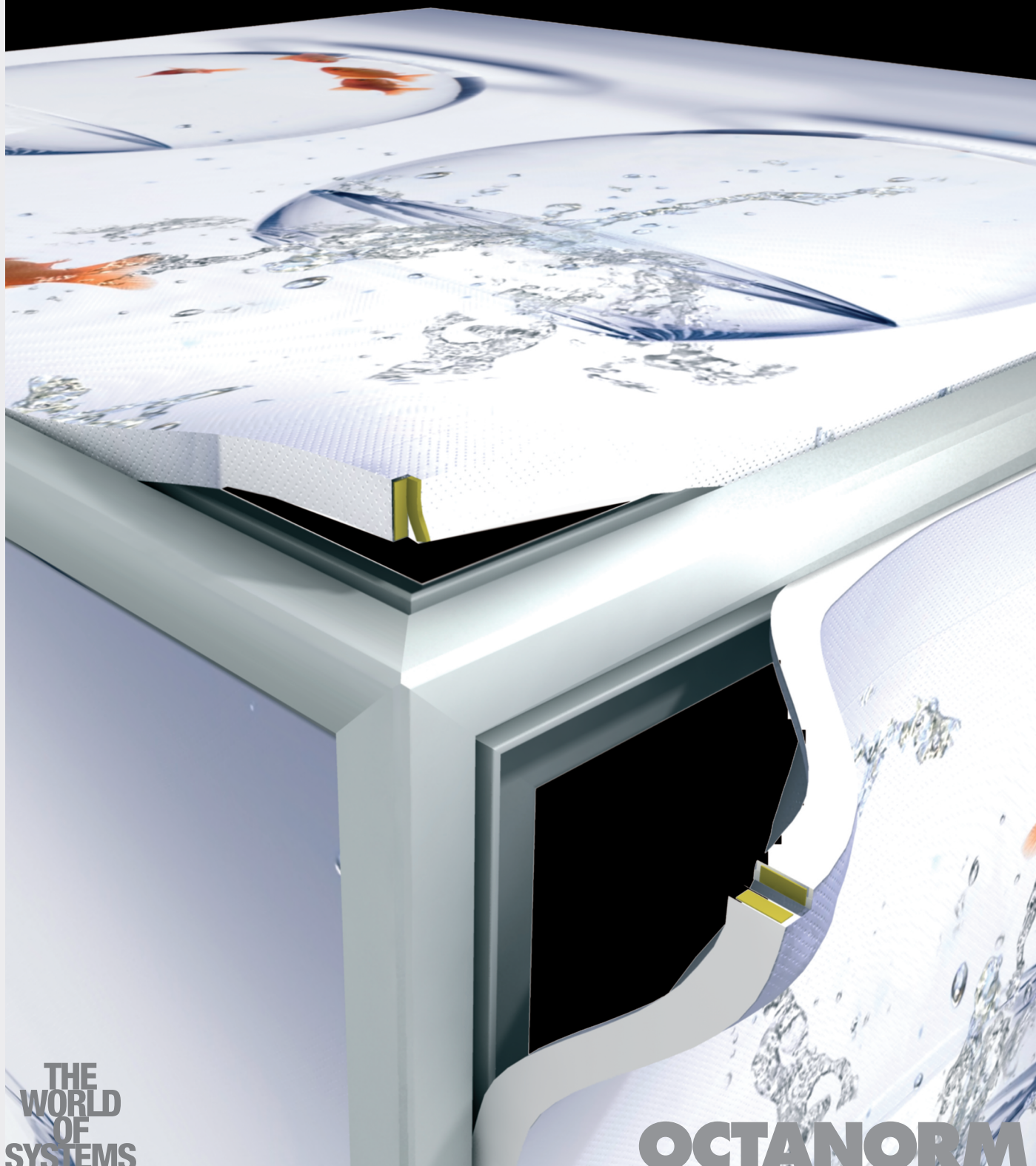

THE
WORLD
OF
SYSTEMS

OCTANORM 

• PARTS AND ACCESSORIES.

• BAUTEILE UND ZUBEHÖR .

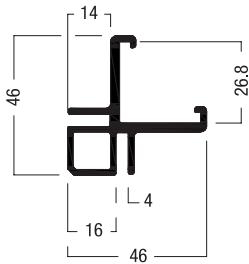

**FABRIC PANEL RETAINER EXTRUSION
KORPUS-STOFFHALTEPROFIL**

M 1332.01

aluminium
for two-sided / 90° elbow fixing of fabrics
in connection with a flexible silicone strip M 1313
6000 mm long
13.10 lbs

Aluminium
für Befestigung von Stoffelementen "zweiseitig / 90° versetzt"
in Verbindung mit Silikonkeder M 1313
6000 mm lang
5,94 kg

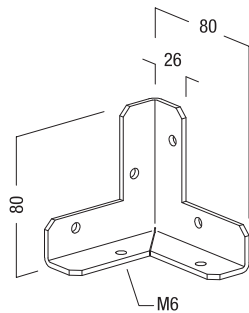
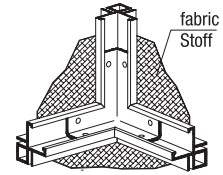

**KNUCKLE JOINT
ECKVERBINDER**

M 1334.37

steel
for mounting 3 fabric panel retainer extrusions M 1332
0.46 lbs

Stahl
zum Anschluss von 3 Korpus-Stoffhalteprofilen M 1332
0,21 kg

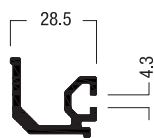
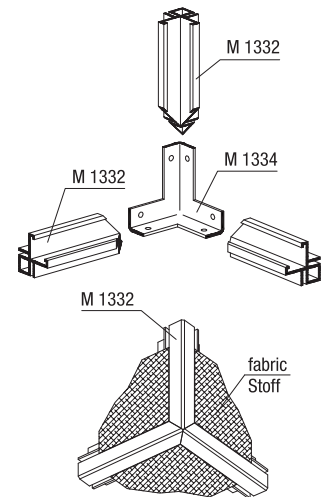

**ADAPTOR EXTRUSION
ADAPTERPROFIL**

M 1326.01

aluminium
can only be inserted lengthwise
in fabric panel retainer extrusion M 1332
6000 mm long
7.21 lbs

Aluminium
kann nur in Längsrichtung in Korpus-Stoffhalteprofil M 1332
eingeschoben werden
6000 mm lang
3, 27 kg

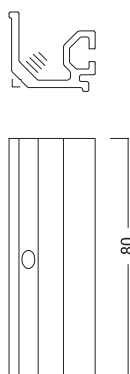

**ADAPTOR
ADAPTER**

M 1329.01

aluminium
with 1x clamping screw M6 to fix to extrusion M 1332
for connection of 16 mm beam extrusions
80 mm long
0.95 lbs

Aluminium
mit 1 x Klemmschraube M6 für Befestigung in Profil M 1332
für Anschluss von 16 mm-Zargenprofilen
80 mm lang
0,43 kg

